

KOLTEC USA



Backup & Hand Pads

A Growing American Manufacturer

RESIN FIBER DISC PADS



SMOOTH FACE RFD PADS

These pads are made from proprietary thermoplastic rubber compounds that provides consistent properties over a wide range of temperatures. They are ideal pads for general purpose applications using resin fiber discs with grits 36 and finer . All pads are for RFD discs with 7/8" holes except #151300 and #151296 are for 5/8" arbor hole discs.

Retaining nuts are included. See Page 12 for wrench and spare nuts.

EDP #	PAD #	DIAM	ARBOR	FLEX	RPM
151298	336-ST-5	4"	5/8-11	Medium	15,000
151300	491-ST-M102	4"	M10x1.25	Medium	15,000
151296	491-ST-M105	4"	M10x1.5	Medium	15,000
151330	339-ST-3	4½"	3/8-24	Medium	13,000
151302	339-ST-5	4½"	5/8-11	Medium	13,000
151332	339-ST-M14	4½"	M14	Medium	13,000
151304	335-ST-5	5"	5/8-11	Medium	12,000
151305	335-ST-M14	5"	M14	Medium	12,000
151306	309-ST-5	7"	5/8-11	Medium	8,500
151312	420-SF-5	7"	5/8-11	Soft	8,500
151308	326-ST-5	9"	5/8-11	Medium	6,600



RIBBED FACE AIR COOLED RFD PADS

Ideal for coarse grit grinding and most general purpose applications. Recommended with grits 50 and coarser. These pads are a revised and improved design. Airflow holes have been added to promote more flow under the disc, and the pads are now a flat T-27 . If you formerly used these pads the EDP number remains the same but the PAD# has changed as follows: 472 is now 707, 471 is now 708, and 488 is now 721.

The heavy duty glass reinforced pads are significantly more heat resistant. They are recommended for use on stainless steel.

Retaining nuts are included. See Page 12 for wrench and spare nuts.

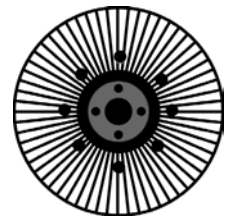

EDP #	PAD #	DIAM	ARBOR	FLEX	RPM
General purpose for light applications					
151294	525-VC-5	4"	5/8-11	Firm	13,000
151342	707-VC-5	4½"	5/8-11	Firm	13,000
151338	708-VC-5	5"	5/8-11	Firm	12,000
151344	721-VC-5	7"	5/8-11	Firm	8,500
Heavy duty glass reinforced for severe applications					
151314	707-HL-5	4½"	5/8-11	Firm	13,000
151340	707-HL-M14	4½"	M14	Firm	13,000
151316	708-HL-5	5"	5/8-11	Firm	12,000
151336	708-HL-M14	5"	M14	Firm	12,000
151318	721-HL-5	7"	5/8-11	Firm	8,500
151320	527-HL-5	9"	5/8-11	Firm	6,600



RESIN FIBER DISC PADS

MOLDED RUBBER AIR COOLED PADS

Koltec USA's "Spirub" molded rubber pads feature spiral cooling fins. They are available in four sizes with or without the retaining nut. Each pad threads on to the tool shaft. These pads are comparable to any molded rubber pads on the market.



EDP #	PAD #	DESCRIPTION	RPM
151751	601-SR45M	4-1/2" x 5/8-11 Spirub RFD pad Medium	13,500
151751N	601-SR45MN	4-1/2" x 5/8-11 Spirub RFD pad Medium with nut	13,500
151752	601-SR50M	5" x 5/8-11 Spirub RFD pad Medium	13,000
151752N	601-SR50MN	5" x 5/8-11 Spirub RFD pad Medium with nut	13,000
151753	601-SR70M	7" x 5/8-11 Spirub RFD pad Medium	8,600
151753N	601-SR70MN	7" x 5/8-11 Spirub RFD pad Medium with nut	8,600
151754	601-SR70F	7" x 5/8-11 Spirub RFD pad Flexible	8,600
151754N	601-SR70FN	7" x 5/8-11 Spirub RFD pad Flexible with nut	8,600
151756	601-SR90M	9" x 5/8-11 Spirub RFD pad Medium	6,600
151756N	601-SR90MN	9" x 5/8-11 Spirub RFD pad Medium with nut	6,600

Conversion Chart

Diam	Spiralcool	EDP #
4 1/2"	R425	151751
5"	R500-R	151752
7"	R700-R	151753
7"	F700-R	151754
9"	R900-R	151756

The pads on this page thread on to the tool arbor, and can be used with quick change resin fiber discs

HIGH PERFORMANCE PRODUCTION PADS

These pads are an economic choice for high performance applications with 7" resin fiber discs. The pads thread on to the 5/8-11 tool arbor which allows them to be used with quick change discs. Available in four smooth face and two ribbed face flexes. The pads include a mounting nut. They are rated at 8,500 max RPM.

These are a lower cost alternative to the rubber pads above.

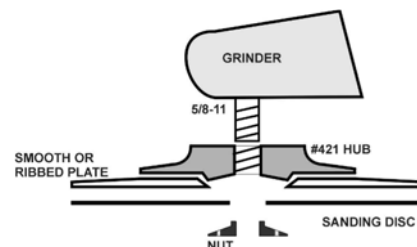

EDP #	PAD #	DESCRIPTION	COLOR
151707S	422-BLK-S	7" x 5/8-11 Smooth face Firm	Black
151706S	422-GRY-S	7" x 5/8-11 Smooth face Medium Firm	Gray
151705S	422-BLU-S	7" x 5/8-11 Smooth face Medium Soft	Blue
151704S	422-ORG-S	7" x 5/8-11 Smooth face Soft	Orange
151708S	423-BLK-S	7" x 5/8-11 Ribbed face Firm	Black
151709S	423-GRY-S	7" x 5/8-11 Ribbed face Medium	Gray



Smooth Face Pad 422-BLU-S



Ribbed Pad 423-BLK-S

RANDOM ORBIT DA PADS - PSA DISCS

KOLTEC DA (dual action) pads for PSA adhesive backed abrasive discs are polyurethane molded with a strong fiberglass or glass reinforced poly back plate. Available in the classic tapered edge style and the low profile square edge

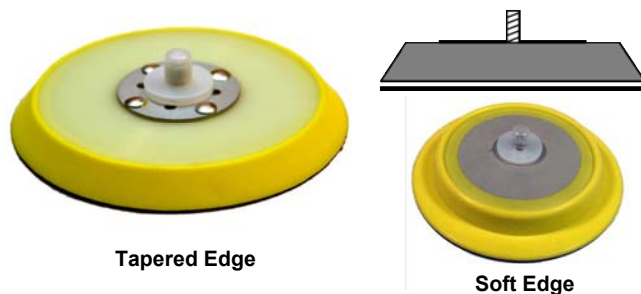

Tapered Edge

Soft Edge

TAPERED EDGE PADS POLYURETHANE PADS

EDP #	PAD #	DIAM	ARBOR	FLEX	SURFACE	VAC Ø	RPM
151376	528-DAA	5"	5/16-24	Med-Firm	Vinyl	None	14,000
151378	530-DAAV	5"	5/16-24	Med-Firm	Vinyl	5	14,000
151370	498-DAA	5"	5/16-24	Med-Soft	Vinyl	None	12,000
151822	580-DAA	5"	5/16-24	Soft Edge	Vinyl	None	10,000
151740	4025-DAA-31-M8*	5"	M8 male	Medium	Vinyl	None	4,500
151365	501-DAAV	5"	5/16-24	Med-Soft	Vinyl	5	12,000
151380	531-DAA	6"	5/16-24	Med-Firm	Vinyl	None	12,000
151382	532-DAAV	6"	5/16-24	Med-Firm	Vinyl	6	12,000
151374	496-DAA	6"	5/16-24	Med-Soft	Vinyl	None	10,000
151387	506-DAAV	6"	5/16-24	Med-Soft	Vinyl	8	10,000

* Has a plastic back plate

TAPERED EDGE PADS WITH GLASS REINFORCED POLY BACK

KOLTEC glass reinforced poly back pads provide a cost saving design. Use these pads as a substitute for the fiberglass backed pads listed above. The corresponding pad style is listed in parenthesis. These pads are being discontinued and sales are limited to stock on hand. They are technically sound.



EDP #	PAD #	DIAM	ARBOR	FLEX	SURFACE	VAC Ø	RPM
151815	652-DAA (496)	6"	5/16-24	Med-Soft	Vinyl	None	10,000

LOW PROFILE PADS FOR SOFTER EDGE

KOLTEC low profile pads have a soft outer edge. These are popular for both woodworking and automotive applications.

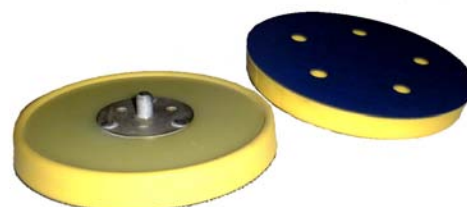

EDP #	PAD #	DIAM	ARBOR	FLEX	SURFACE	VAC Ø	RPM
151720	505-DAA	5"	5/16-24	Med-Soft	Vinyl	None	10,000
151721	597-DAAV	5"	5/16-24	Med-Soft	Vinyl	5	10,000
151722	474-DAA	6"	5/16-24	Med-Soft	Vinyl	None	10,000
151723	487-DAAV	6"	5/16-24	Med-Soft	Vinyl	6	10,000

RANDOM ORBIT DA PADS - HOOK & LOOP DISCS

KOLTEC DA (dual action) pads for hook & loop backed abrasive discs are polyurethane molded with a strong fiberglass or glass reinforced poly back plate. Available in the classic tapered edge style and a low profile square edge style.

TAPERED EDGE POLYURETHANE PADS

EDP #	PAD #	DIAM	ARBOR	FLEX	SURFACE	VAC Ø	RPM
151736	542-DAHV52	3"	5/16-24	Med-Soft	H&L	None	12,000
151741	4025-DAH-31-M8*	5"	M8 male	Medium	H&L	None	4,500
151384	528-DAH	5"	5/16-24	Med-Firm	H&L	None	14,000
151386	530-DAHV	5"	5/16-24	Med-Firm	H&L	5	14,000
151371	498-DAH	5"	5/16-24	Med-Soft	H&L	None	12,000
151367	501-DAHV	5"	5/16-24	Med-Soft	H&L	5	12,000
151393	500-DAHV	5"	5/16-24	Med-Soft	H&L	8	12,000
151388	531-DAH	6"	5/16-24	Med-Firm	H&L	None	12,000
151390	532-DAHV	6"	5/16-24	Med-Firm	H&L	6	12,000
151391	533-DAHV	6"	5/16-24	Med-Firm	H&L	8	12,000
151375	496-DAH	6"	5/16-24	Med-Soft	H&L	None	10,000

* Laminated pad construction.

TAPERED EDGE PADS WITH GLASS REINFORCED POLY BACK

KOLTEC glass reinforced poly back pads provide a cost saving design. Use these pads as a substitute for the fiberglass backed pads listed above. The corresponding pad style is listed in parenthesis. These pads are being discontinued and sales are limited to stock on hand. They are technically sound.

EDP #	PAD #	DIAM	ARBOR	FLEX	SURFACE	VAC Ø	RPM
151810	625-DAH (528)	5"	5/16-24	Med-Firm	H&L	None	14,000
151813	650-DAH (498)	5"	5/16-24	Med-Soft	H&L	None	12,000
151817	627-DAH (531)	6"	5/16-24	Med-Firm	H&L	None	12,000
151816	652-DAH (496)	6"	5/16-24	Med-Soft	H&L	None	10,000

LOW PROFILE PADS FOR SOFTER EDGE

KOLTEC low profile pads have a soft outer edge. These are popular for both woodworking and automotive applications.

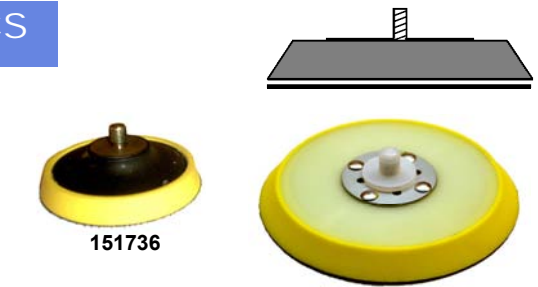

151736

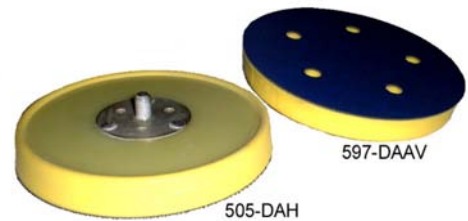

505-DAH

597-DAAV

EDP #	PAD #	DIAM	ARBOR	FLEX	SURFACE	VAC Ø	RPM
151397	598-DAH	4½"	5/16-24	Med-Soft	H&L	None	12,000
151725	505-DAH	5"	5/16-24	Med-Soft	H&L	None	10,000
151726	597-DAHV	5"	5/16-24	Med-Soft	H&L	5	10,000
151727	474-DAH	6"	5/16-24	Med-Soft	H&L	None	10,000
151728	487-DAHV	6"	5/16-24	Med-Soft	H&L	6	10,000

RANDOM ORBIT DA PADS - SCD DISCS

KOLTEC DA pads for nonwoven SCD discs are laminated with a black 1/2" thick foam interlayer, and a Gripper "T" extra long hook surface. They will hold either scrim back SCD discs or plain SCD material. For use with random orbit sanders.

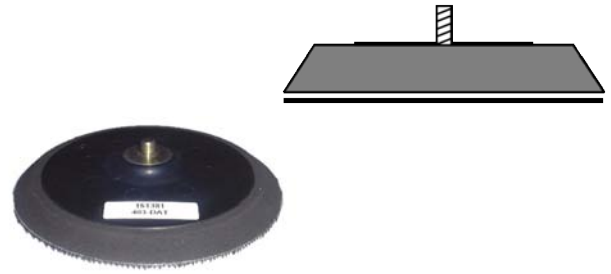

EDP #	PAD #	DIAM	ARBOR	FLEX	SURFACE	VAC Ø	COLOR	RPM
151369	401-DAT	4½"	5/16-24	Med-Soft	Gripper T	None	Black	13,000
151385	4015-DAT	5"	5/16-24	Med-Soft	Gripper T	None	Black	12,000
151381	403-DAT	6"	5/16-24	Med-Soft	Gripper T	None	Black	10,000

INTERFACE PADS

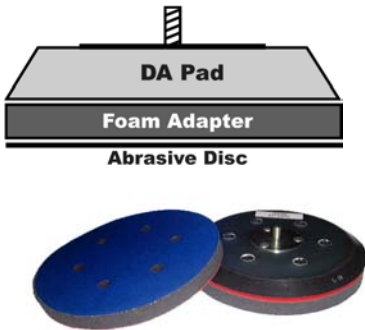

Use to soften the flex of DA and straight rotation pads. Other sizes and configurations can be special ordered.

EDP #	PAD #	DIAM	THICK	TOOL SIDE	DISC SIDE	VAC Ø
151005	3DAP-VVN	3"	0.5"	H&L	H&L	None
151002	5DAP-VVN	5"	0.5"	H&L	H&L	None
151004	5DAP-VV5	5"	0.5"	H&L	H&L	5
151008	5DAP-VPN	5"	0.5"	H&L	PSA	None
151010	5DAP-VP5	5"	0.5"	H&L	PSA	5
151014	6DAP-VVN	6"	0.5"	H&L	H&L	None

PADS FOR PSA AND GLUE DISCS

Koltec cushioned pads for PSA adhesive back and glue-on discs are designed for tools with straight rotation, not dual action. They have a sturdy back plate with female 5/8-11 threaded arbor. They can be adapted to fit other power tool shafts with our adapters shown on Page 12. PSA pads have a blue vinyl surface and glue disk pads have a canvas surface.



640, 641, & 642 Style



Soft Edge Style



Thick Edge Style

EDP #	PAD #	DIAM	ARBOR	FLEX	SURFACE	COLOR	RPM
151417	640-A-5	5"	5/8-11	Med-Soft	Blue Vinyl	Yellow	7,000
151444	580-AS-5	5"	5/8-11	Soft Edge	Blue Vinyl	Yellow	8,500
151445	581-AS-5	5"	5/8-11	Thick Edge	Blue Vinyl	Yellow	8,500
151446	581-GS-5	5"	5/8-11	Thick Edge	Canvas	Yellow	8,500
151418	641-A-5	6"	5/8-11	Med-Soft	Blue Vinyl	Yellow	5,730
151424	642-A-5	7"	5/8-11	Med-Soft	Blue Vinyl	Yellow	4,910

SPINDLE PADS FOR PSA & H&L DISCS

These spindle pads are designed to hold small diameter PSA or H&L discs. The pad diameters are slightly undersized by design to protect the edge. Shanks are threaded and can be removed leaving a 1/4-20 female arbor.

ABRAS DIAMETER	PAD DIAMETER	SHANK	PSA PADS		H & L PADS	
			EDP #	PAD #	EDP #	PAD #
3/4"	0.75"	1/4"	151039	405-AM-4S		
1"	0.91"	1/4"	151040	413-AM-4S	151057	413-HM-4S
1 1/4-1 1/2"	1.17"	1/4"	151042	406-AM-4S		
2"	1.85"	1/4"	151044	407-AM-4S	151058	407-HM-4S
3"	2.87"	1/4"	151048	409-AM-4S	151059	409-HM-4S

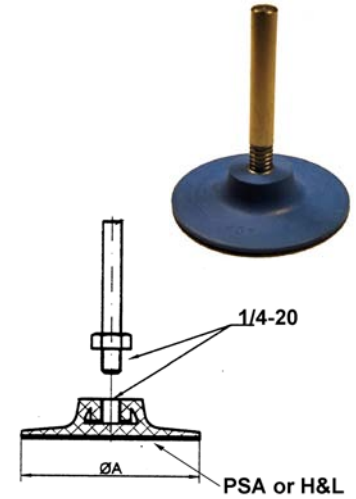

PADS FOR H&L DISCS

KOLTEC USA's pads for H&L discs are typically used in finishing and polishing applications with H&L abrasive or diamond discs. Pads with water feed holes are commonly used in the polishing of marble, granite, and other ceramic material in a wet mode. They can be used in both wet and dry applications.

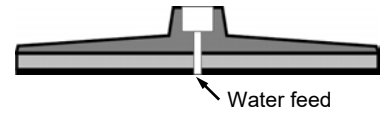

Spindle pads with 1/4" shank



Pads with foam interlayer and a water feed hole. Can be used wet or dry.



Pads without foam layer for firmer action. Available with or without water hole.

EDP #	PAD #	DIAM	ARBOR	SURFACE	FOAM	WATER Ø	RPM
151052	SP2-3-H	2"	1/4" Shank	H&L	3/4"	No	6,000
151053	SP3-3-H	3"	1/4" Shank	H&L	3/4"	No	6,000
151405	355-1MH3126W-5	3"	5/8-11	H&L	1/2"	Yes	20,190
151406	355-1MH3125-3	3"	3/8-24	H&L	1/2"	No	20,190
151409	399-1MH3126W-5	4"	5/8-11	H&L	1/2"	Yes	15,000
151606	399-1LHW-5	4"	5/8-11	H&L	None	Yes	15,000
151601	375-1LH-5	4 1/2"	5/8-11	H&L	None	No	13,000
151414	376-1MH3126W-5	5"	5/8-11	H&L	1/2"	Yes	12,000
151607	376-1LHW-5	5"	5/8-11	H&L	None	Yes	12,000
151605	376-1LH-5	5"	5/8-11	H&L	None	No	12,000
151611	376-1LH-M14	5"	M14	H&L	None	No	12,000
151429	314-1MH3126W-5	6"	5/8-11	H&L	1/2"	Yes	10,000
151602	314-1LH-5	6"	5/8-11	H&L	None	No	10,000
151430	392-1MH3126W-5	7"	5/8-11	H&L	1/2"	Yes	8,500
151617	392-1LH-5	7"	5/8-11	H&L	None	No	8,500
151433	337-1MH3126W-5	8"	5/8-11	H&L	1/2"	Yes	7,570
151434	337-1MH3426-5 (firm)	8"	5/8-11	H&L	3/8"	No	7,570

GRIPPER PADS FOR NONWOVEN SCD DISCS

KOLTEC pads for nonwoven surface conditioning discs (SCD) have a Gripper "T" extra long hook surface. The 5/8-11 pads for grinder/sanders have flats on the back for easy installation and removal from the tool arbor. All gripper pads are industrial grade.

NOTE: This style pad is generally not recommended for use with H&L backed sanding abrasive discs. See the pads on Page 7 for use with H&L sanding discs.

NOTE: #151410 and #151415 have a water feed hole for wet use

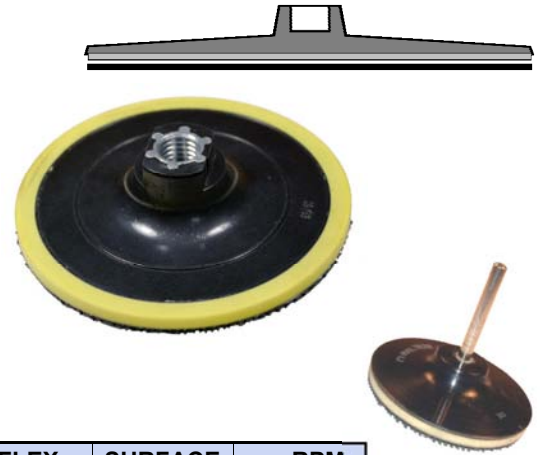

EDP #	PAD #	TYPE	DIAM	ARBOR	FLEX	SURFACE	RPM
151179	406-GR-4S	For collet or chucks	1½"	1/4" shank	Medium	Gripper T	19,000
151364	407-GR-4S	For collet or chucks	2"	1/4" shank	Medium	Gripper T	19,000
151366	409-GR-4S	For collet or chucks	3"	1/4" shank	Medium	Gripper T	11,000
151403	399-1MT31-5-B	For grinder/sander	3-1/2"	5/8-11	Med-Soft	Gripper T	13,285
151347	399-GR-4S	For collet or chucks	4"	1/4" shank	Medium	Gripper T	15,000
151350	399-GR-5	For grinder/sander	4"	5/8-11	Medium	Gripper T	15,000
151410	399-1MT3126W-5	For grinder/sander	4"	5/8-11	Soft	Gripper T	15,000
151352	375-GR-5	For grinder/sander	4½"	5/8-11	Medium	Gripper T	13,000
151354	375-GR-M14	For grinder/sander	4½"	M14	Medium	Gripper T	13,000
151356	376-GR-5	For grinder/sander	5"	5/8-11	Medium	Gripper T	12,000
151404	376-1MT31-5-B	For grinder/sander	5"	5/8-11	Soft	Gripper T	12,000
151358	376-GR-M14	For grinder/sander	5"	M14	Medium	Gripper T	12,000
151415	376-1MT3126W-5	For grinder/sander	5"	5/8-11	Soft	Gripper T	12,000
151348	314-GR-5	For grinder/sander	6"	5/8-11	Medium	Gripper T	10,000
151360	392-GR-5	For grinder/sander	7"	5/8-11	Medium	Gripper T	8,500
151362	392-GR-M14	For grinder/sander	7"	M14	Medium	Gripper T	8,500
151355	392-1MT3126-5	For grinder/sander	7"	5/8-11	Soft	Gripper T	8,500
RANDOM ORBIT DA PADS							
151369	401-DAT	DA Pad	4½"	5/16-24	Soft	Gripper T	13,000
151385	4015-DAT	DA Pad	5"	5/16-24	Soft	Gripper T	12,000
151381	403-DAT	DA Pad	6"	5/16-24	Soft	Gripper T	10,000

DRILL PAD FOR HOOK & LOOP DISCS

EDP #	PAD #	DIAM	ARBOR	SURFACE	RPM
151060	567-DH-8mm	5"	3/8" (8mm)	Velcro	1,200

KOLTEC drill pad for 5" hook & loop discs is sturdily built with a shank to fit drill with a 3/8" chuck. It can be locked in the rigid position or unlocked to use at a slight angle. A great DIY item.



HOLDERS FOR QUICK CHANGE DISCS

HEAVY DUTY COMBO 1/4 SHANK & 5/8-11

KOLTEC heavy duty style holders are available for both Type R "Rolloc®" style and Type S metal clip style quick change discs. Each holder comes with 1/4" straight shank and can also be used without the shank on a 5/8-11 power tool arbor for maximum versatility.

Inserts available (Pg 12) to convert holders to fit the following male tool arbors:

- 5/8-11
- 3/8-24
- M10x1.25
- M10x1.5

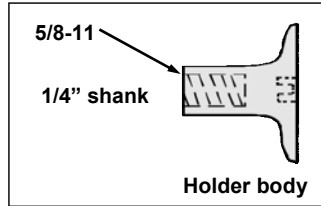

FOR TYPE R ROLLOC® STYLE

FOR TYPE S CLIP STYLE



EDP #	PAD #	DIAM	FLEX
151202	563-QL-4S	1½"	Med
151217	563-QLS-4S	1½"	Soft
151204	564-QL-4S	2"	Med
151221	564-QLS-4S	2"	Soft
151206	565-QL-4S	3"	Med
151225	565-QL-M14	3"	Med

EDP #	PAD #	DIAM	FLEX
151208	563-QC-4S	1½"	Med
151215	563-QCS-4S	1½"	Soft
151210	564-QC-4S	2"	Med
151219	564-QCS-4S	2"	Soft
151212	565-QC-4S	3"	Med
151226	565-QC-M14	3"	Med

Max RPM

- 1½" - 25,000
- 2" - 19,000
- 3" - 12,000

#151225 and 151226 are base only the M14 female arbor.

LOW PROFILE STYLE

KOLTEC low profile holders are available in both Type R and Type S. They have a thinner profile that is ideal for working in tight places.



LOW PROFILE TYPE R

LOW PROFILE TYPE S

EDP #	PAD #	DIAM	FLEX
151200	592-QL-4S	1"	Med
151203	593-QL-4S	1½"	Med
151205	594-QL-4S	2"	Med
151207	595-QL-4S	3"	Med

EDP #	PAD #	DIAM	FLEX
151199	592-QC-4S	1"	Med
151209	593-QC-4S	1½"	Med
151211	594-QC-4S	2"	Med
151213	595-QC-4S	3"	Med

Max RPM

- 1" - 40,000
- 1½" - 25,000
- 2" - 19,000
- 3" - 12,000

See next page for rubber style holders.

RUBBER HOLDERS FOR QUICK CHANGE DISCS

KOLTEC rubber holders are a high quality and cost effective version of the traditional pads used industry wide. Manufactured in our Michigan plant. Available for Type R (Rolloc®) and Type S metal clip disc styles.



TRADITIONAL RUBBER HOLDERS
TYPE R

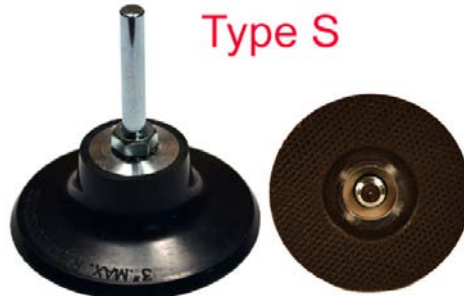

TRADITIONAL RUBBER HOLDERS
TYPE S

EDP #	PAD #	DIAM	FLEX
151453	945-QL-4S	1"	Med
151454	946-QL-4S	1½"	Med
151455	947-QL-4S	2"	Med
151473	947-QLS-4S	2"	Soft
151456	948-QL-4S	3"	Med
151477	948-QLS-4S	3"	Soft
151457	949-QL-4S	4"	Med
151459	951-QL-5	4"	Med

#151459 has a 5/8-11 female arbor—no shank.

EDP #	PAD #	DIAM	FLEX
151462	945-QC-4S	1"	Med
151463	946-QC-4S	1½"	Med
151464	947-QC-4S	2"	Med
151474	947-QCS-4S	2"	Soft
151465	948-QC-4S	3"	Med
151478	948-QCS-4S	3"	Soft

Max RPM

1" - 40,000, 1½" - 30,000, 2" - 30,000,
3" - 20,000, 4" - 10,000

TYPE R PLASTIC BUTTONS FOR QUICK CHANGE DISCS

Our Type R buttons for Rolloc® style discs have a 30 mm diameter base. They are black plastic suitable for either adhesive or friction weld bonding. Buttons are bulk packed 5,000 to a box.

Part number 151785 for standard 30 mm T-R-But 30 black button.



30 mm Button

Special Orders Sizes and Colors

Type R buttons can be ordered with flange diameters of 19 mm and 16 mm. All size buttons can also be ordered in a variety of colors including white, yellow, green, and brown.

HAND PADS



171-172 H&L Strap Style

Flexible 1/4" thick foam pads with a wrist strap. Ideal for sanding curved surfaces. There is a limited supply of the 110 elastic wrist band style, which is being replaced with new 171/172 adjustable Velcro® wrist band style.

EDP #	PAD #	ABRASIVE
151774	171-HPA5	5" PSA Disc
151775	171-HPH5	5" H&L Disc
151246	110-HPA6	6" PSA Disc
151776	172-HPA6	6" PSA Disc
151777	172-HPH6	6" H&L Disc



151268



Allows the use of a standard H&L or PSA discs for hand sanding. The 3" and 5" pad is a soft yellow foam and the 6" is firmer black foam. Pads 151268, 151257, and 151256 have a water reservoir with sponge.

EDP #	PAD #	ABRASIVE
151268	541-HBH3WS	3" H&L Disc
151257	538-HBH5WS	5" H&L Disc
151256	538-HBA5WS	5" PSA Disc
151255	539-HBH6-H	6" H&L Disc
151253	539-HBA6-H	6" PSA Disc

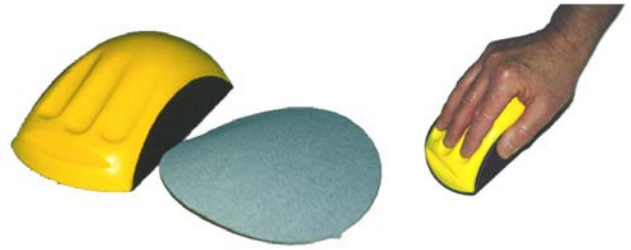

A unique design that quickly converts a 5" or 6" diameter abrasive discs into a hand sander. The pad is ergonomically designed to fit the user's fingers.

EDP #	PAD #	ABRASIVE
151243	596-HBA5	5" PSA Disc
151245	596-HBH5	5" H&L Disc
151242	550-HBA6	6" PSA Disc
151244	550-HBH6	6" H&L Disc



544



545

Allows use of a 5" x 2 3/4" sheets for hand sanding. The block is yellow CELLTEC®.

EDP #	PAD #	ABRASIVE
151250	544-HBA5	5" x 2 3/4" PSA
151252	544-HBH5	5" x 2 3/4" H&L
151258	545-HBA5	5" x 2 3/4" PSA
151260	545-HBH5	5" x 2 3/4" H&L



Allows use of a 5" x 2 3/4" sheets for hand sanding. One side of block has a firm surface for edge sanding, and the other side is soft for sanding curved shapes.

EDP #	PAD #	ABRASIVE
151265	116-HBA-81	5" x 2 3/4" PSA
151263	116-HBH-81	5" x 2 3/4" H&L

PAD ACCESSORIES



I-125-5-4S



I-045-5-3



W-061 Adjustable Pad Nut Wrench



EDP #	KOLTEC #	TYPE
INSERTS TO CONVERT ARBORS		
151536	I-045-5-3	Insert 5/8-11 to 3/8-24
151532	I-045-5-M102	Insert 5/8-11 to M10x1.25
151534	I-045-5-M105	Insert 5/8-11 to M10x1.5
151528	I-045-M-3	Insert M14 to 3/8-24
151524	I-045-M-M102	Insert M14 to M10x1.25
151531	I-125-M-4S	Adapter M14 to 1/4 shank
151529	I-125-5-4S	Adapter 5/8-11 to 1/4 shank
151533	I-4S-M610	Adapter 1/4-20(F) to M6-10(M)
151523	I-124-4S	Shank 1/4-20 to 1/4 Straight
151525	I-124-8S	Shank 1/4-20 to 1/8 Straight
SPARE NUTS FOR RFD PADS		
151514	N-005-5	5/8-11 Nut for 7" and 9" RFD
151516	N-005-M14	M14 Nut for 7" and 9" RFD
151522	N-009-3	3/8-24 Nut for 4" x 5/8" RFD
151518	N-009-M102	M10x1.25 Nut for 4" x 5/8" RFD
151520	N-009-M105	M10x1.5 Nut for 4" x 5/8" RFD
151510	N-016-5	5/8-11 Nut for 4½" and 5" RFD
151512	N-016-M14	M14 Nut for 4½" and 5" RFD
WRENCH FOR RFD PADS		
151550	W-061	Spanner wrench for all nuts

OTHER AVAILABLE PRODUCTS

This catalog includes our most popular back-up pads for the North American abrasive industry. **KOLTEC USA** manufactures most pads in the USA and also supplies the complete range of special pads and accessories from **Koltec Technologiein GmbH**. If the pad you need is not shown, contact us at the numbers listed below. We can supply a complete line of pads for any grinding, sanding, polishing, or buffing job, and we can custom engineer a pad to fit most applications.



USA Manufacturing Plant

KOLTEC USA

Division of Vachon Industries
 PO Box 383, 580 Race Street
 Coldwater, MI 49036

1-800-367-7291 517-278-2354 Fax: 517-279-7265
 Web Site abrasiveproducts.net Email sales@abrasiveproducts.net